



TECHNICAL DATA

Model	From 50 to 4000 mm
Measurement taken	Displacement / Speed
Position read sampling time (typical)	From 0,5 ms to 3 ms (depending on stroke)
Speed measurement range	min 0 .. 0,1 m/s max 0 .. 10 m/s
Accuracy speed	< 2% (in all F.S.)
Shock test DIN IEC68T2-27	100g - 11ms - single shock
Vibrations DIN IEC68T2-6	12g / 10...2000Hz
Displacement speed	≤10 m/s
Max. acceleration	≤ 100 m/s ² displacement
Resolution	16 bit (max electrical noise 5 mVpp)
Cursor (see note)	Sliding cursor Floating separate cursor
Working temperature	-30...+75°C
Storage temperature	-40...+100°C
Coefficient of temperature	0.005% F.S. / °C
Protection	IP67
Note: 1)	For strokes > 2500 mt use sliding or floating cursors with max. distance of 4mm
2)	For multi-cursor versions, the cursors have to work under the same distance and temperature conditions

ELECTRICAL DATA

Output signal	0...10V (N/P/Y)	4...20mA (E/F/H) 0...20mA (B/C/D)
Nominal power supply	24 Vdc ±20%	24 Vdc ±20%
Max. power ripple	1Vpp	1Vpp
Max. consumption	70mA	90mA
Max. output load	5kΩ	< 500Ω
Max. output noise	< 5mVpp	< 5mVpp
Max. output value	12V	30mA
Alarm output value	10.5V	21mA
Electrical isolation	500V (*)	500V (*)
Protection against polarity inversion	Yes	Yes
Protection against overvoltage	Yes	Yes
Protection against power supply in output	Yes	Yes

(*) It includes a 30V 0,4J voltage suppressor

Main characteristics

- ONDA technology
- Optimised mechanical structure
- Strokes from 50 to 4000mm
- Sliding or floating magnetic cursor
- Availability of several analogue outputs (voltage or current) for direct position and speed measurement or reverse measurement (only position)
- Single or double cursors models availability
- Power supply 24Vdc ±20%
- Resistance to vibration (DINIEC68T2/612g)
- IP67 protection
- Work temperature: -30...+75°C

Contactless linear position transducer with ONDA magnetostrictive technology.

The absence of electrical contact on the cursor eliminates all wear and guarantees almost unlimited life.

Compact size for simple installation.

Full protection against outside agents for use in harsh environments with high contamination and presence of dust.

Excellent linearity, repeatability, resistance to mechanical vibrations and shocks.

MECHANICAL DIMENSIONS

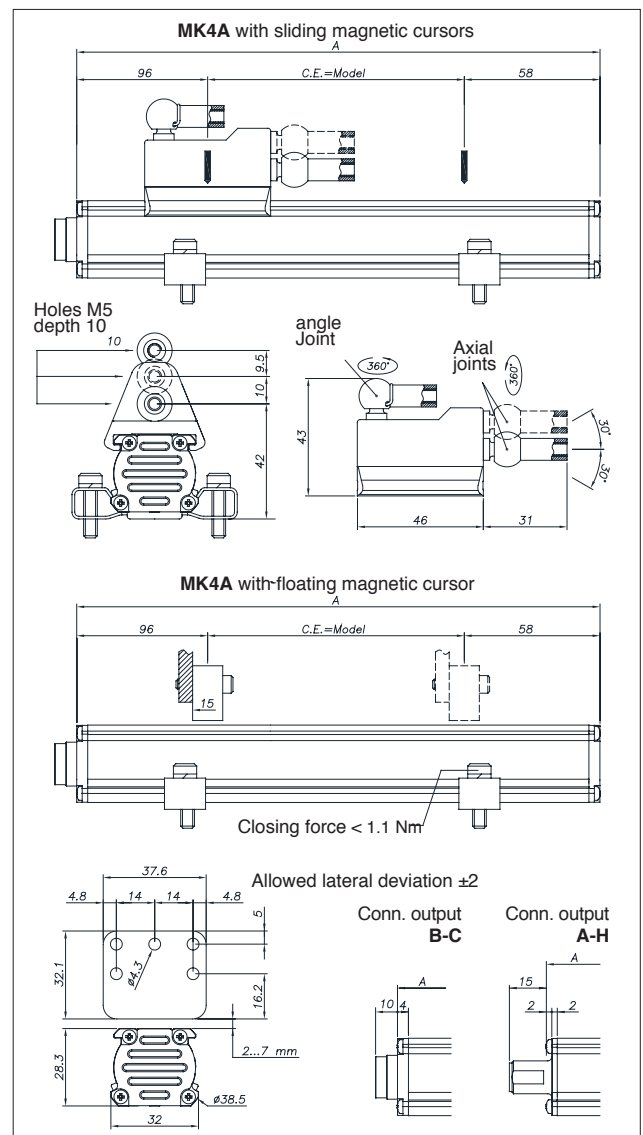

ELECTRICAL / MECHANICAL DATA

Model	50		75		100		130		150		350		360		400		450		500		550		600		650		1200		1250		1300		1400		2250		2500		2750		3000		3250		3500		3750		4000	
	175	200	225	250	300	700	750	800	850	900	950	1000	1100	1500	1750	2000																																		
Sampling time	ms	0,5					1					1,5					2					3																												
Electrical stroke	mm	Model																																																
Independent linearity	±%F.S.	Typical : $\leq \pm 0,01$ % FS (min $\pm 0,060$ mm) with sliding cursor max : $\leq \pm 0,02$ % FS with floating cursor at a distance between 2 and 5 mm max : $\leq \pm 0,04$ % FS with floating cursor at a distance between 5 and 7 mm																																																
Max.dimensions (A)	mm	Modell +154																																																
Repeatability	mm	<0,01 (limited by the resolution of the output value)																																																
Hysteresis	mm	<0,01 (limited by the resolution of the output value)																																																

ELECTRICAL CONNECTIONS

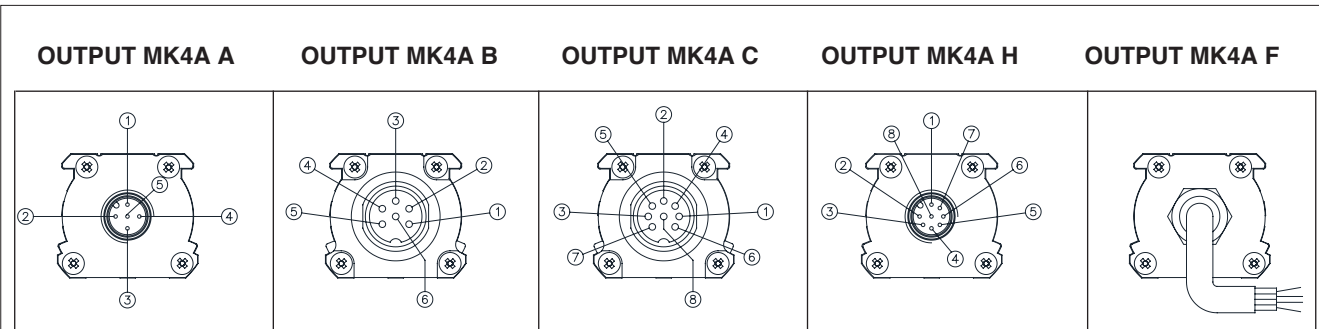

Function	CONNECTORS				CABLES	OPTIONAL CABLES FOR	
	MK4A-A	MK4A-B	MK4A-C	MK4A-H	MK4A-F	MK4A-A	MK4A-H
	5 pin M12	6 pin M16	8 pin M16	8 pin M12	Standard cable	pre-assembled 5 pin	pre-assembled 8 pin
Output cursor 1 0...10V 4...20mA 0...20mA	1	1	5 (1*)	5	Grey	Brown	Green
GND Output cursor 1 (0V)	2	2	2	1	Pink	White	Yellow
Inverse output cursor 1 Output cursor 2 Output speed 0...10V 4...20mA 0...20mA	3	3	3	3	Yellow	Blue	Pink
GND Output cursor 1 Output cursor 2 Output speed (0V)	2	4	6	2	Pink	White	Grey
Power supply+	5	5	7	7	Brown	Grey	Brown
Power supply GND	4	6	8	6	White	Black	Blue
n.c.	-	-	4	4	-	-	Red
n.c.	-	-	1(5*)	8	-	-	White

(*) = for version 4...20mA / 0...20mA

The transducer case must be grounded with the cable sheathing on the control system side only.

ORDER CODE

Position
transducer

M K 4 A

Analog output A

Connector

M12 5-pin connector output A

Available on request

DIN45322 6-pin connector output B

DIN45326 8-pin connector output C

M12 8-pin connector output H

PVC cable output F

Model

Output		
0...10Vdc	1 cursor	N
0...10Vdc	1 cursor, position and speed	P
0...10Vdc	2 cursors (min. stroke 360mm)	Y
4...20mA	1 cursor	E
4...20mA	1 cursor, position and speed	F
4...20mA	2 cursors (min. stroke 360mm)	H
Available on request		
0...20mA	1 cursor	B
0...20mA	1 cursor, position and speed	C
0...20mA	2 cursors (min. stroke 360mm)	D
0...+5Vdc	1 cursor	K

0 0 0 0 X 0 0 0 X 0 0 X 0 X X

Output of speed

Only for analogic output option C, F, P

Maximum measurable speed:
0.1...10.0 m/s

00.0 Function not required

00	B, A, C, H Outputs
Output F cable length	
00	1 m
05	5 m
10	10 m
15	15 m

Mechanical and/or electrical characteristics differing from those in the standard version may be arranged on request.

Es.: MK4-A-B-0400-N, PKIT090, PCUR035

Transducer model MK4, analog output, 6-pin connector, model 400, 0...10Vdc output, PKIT090 brackets, PCUR035 standard cursor.

CURSORS ON REQUEST

P C U R

Cursors

Sliding cursor , axial joint (low) (STANDARD)	035
Sliding cursor, axial joint (high)	036
Sliding cursor, angled joint	037
Floating Cursor	039

PCUR035

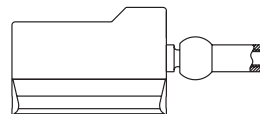

PCUR036

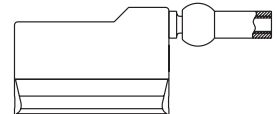

PCUR037

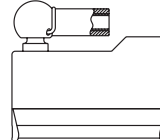

PCUR039

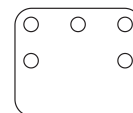

BRACKET S ON REQUEST

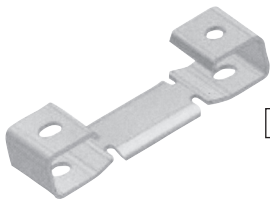

P K I T □ □ □

Brackets (2 brackets for every kit)	
Bracket in steel, interaxis 42.5mm	090
Bracket in steel, interaxis 50mm	091

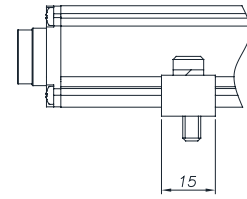
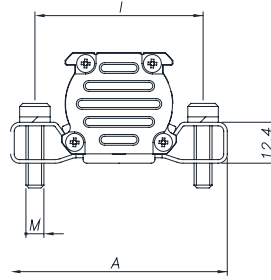

Brackets code	Interaxis (i)	Screw (V)	Dimension (A)
PKIT090	42.5	M4	56
PKIT091	50	M5	63.5

OPTIONAL FEMALE CONNECTORS

For A-H outputs, M12 thread connector

Code: **CON031** for 5-pin output (MK4A A)
CON041 for 5-pin output (MK4A A)
CON035 for 8-pin output (MK4A H)
CON042 for 8-pin output (MK4A H)

For B-C outputs, M16 thread connector

Code: **CON021** for 6-pin output (MK4A B)
CON022 for 6-pin output (MK4A B)
CON023 for 6-pin output (MK4A B)
CON026 for 8-pin output (MK4A C)
CON027 for 8-pin output (MK4A C)
CON028 for 8-pin output (MK4A C)

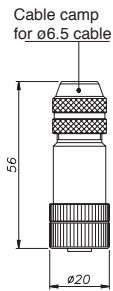

CON031
CON035
IP67 - IEC 48B

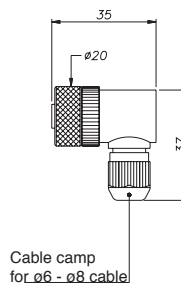

CON041
CON042
IP67

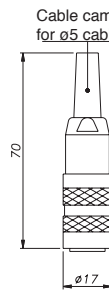

CON021
CON026
IP40 - EMC

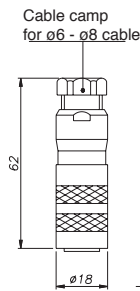

CON022
CON027
IP67 - EMC

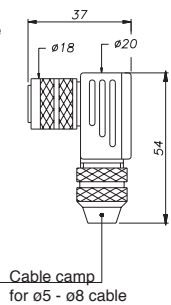

CON023
CON028
IP67 - EMC

Connector extraction length: 10mm

OPTIONAL CABLES OUTPUT

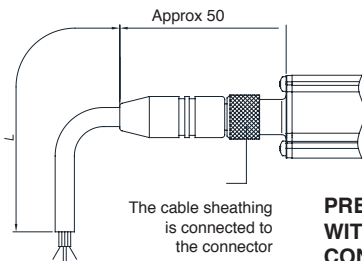

PRE-ASSEMBLED CABLE WITH STRAIGHT CONNECTOR

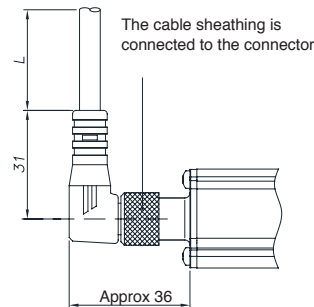

PRE-ASSEMBLED CABLE WITH 90° CONNECTOR

5-pin cable code		MK4A - A	
Lenght "L"		CODE	
		straight cable	Cable to 90°
2	mt	CAV011	CAV021
5	mt	CAV012	CAV022
10	mt	CAV013	CAV023
15	mt	CAV015	CAV024

8-pin cable code		MK4A - H	
Lenght "L"		CODE	
		straight cable	Cable to 90°
2	mt	CAV002	CAV005
5	mt	CAV003	CAV006
10	mt	CAV004	CAV007
15	mt	CAV009	CAV008

Sensors are manufactured in compliance with:

- EMC 2014/30/EU compatibility directive
- RoHS 2011/65/EU directive

Electrical installation requirements and Conformity certificate are available on our web site: www.gefran.com

GEFRAN spa reserves the right to make aesthetic or functional changes at any time and without notice

GEFRAN

GEFRAN spa
 via Sebina, 74
 25050 PROVAGLIO D'ISEO (BS) - ITALIA
 ph. 0309888.1 - fax. 0309839063
 Internet: <http://www.gefran.com>

DTS_MK4A-ONDA_04-2016_ENG