

DIN W72×H36mm, W96×H48mm, digital multi panel meter

■ Features

- Super version of panel meter
- Various output options(Default : Indicator)
RS485 Communication output, Low speed serial output, Current(4-20mA), BCD output, NPN/PNP open collector output, Relay output
- Max. measuring input specification : 500VDC, 500VAC, 5ADC, 5ACA
- Max. display range : -1999 to 9999
- High/Low scale function
- **AC frequency measurement function : 0.1 to 9999Hz**
- Various functions : Monitoring function for max. and min. display value function, display cycle delay function, **Zero function**, High display correction function, **Current output scale function**
- Wide range of power supply : 12-24VDC, 100-240VAC



⚠ Please read "Caution for your safety" in operation manual before using.



※ Upgraded version is released on April of 2006.
Refer to the 4th Autonics catalogue for the before version.

■ Ordering information

MT 4 W - DV - 4 N

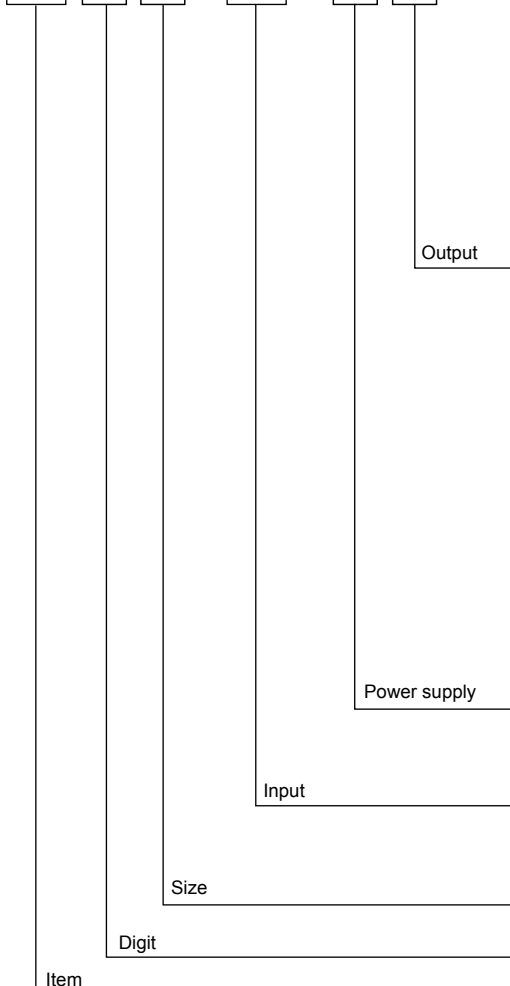

N	Indicator(Without output function)
0	Relay contact output
1	NPN open collector output
2	PNP open collector output
3*1	Relay contact output+Transmission output(DC4-20mA)
4*1	Relay contact output+RS485 communication output
5	BCD dynamic output
6	Low speed serial output

※Output(0 to 6) : Option
※1: Relay contact output of 3, 4 is able only to Low out.

N	Indication type(No output function)
0	Relay contact output+Transmission output(DC4-20mA)
1	Relay contact output
2	NPN open collector output+BCD dynamic output
3	PNP open collector output+BCD dynamic output
4	NPN open collector output+Transmission output(DC4-20mA)
5	PNP open collector output+Transmission output(DC4-20mA)
6	NPN open collector output+Low speed serial output
7	PNP open collector output+Low speed serial output
8	NPN open collector output+RS485 output
9	PNP open collector output+RS485 output

※Output(0 to 9) : Option

1	12-24VDC
4	100-240VAC
DV	DC Voltage
DA	DC Ampere
AV	AC Voltage
AA	AC Ampere
Y	DIN W72×H36mm
W	DIN W96×H48mm
4	9999(4digit)
MT	Multi meter

※To measure the current over DC 5A, please select DV type because the shunt should be used.

※In case of selecting frequency display, no output will be provided even if it is output support models. (Main output, Sub output and RS485 output)

(A)	Photo electric sensor
(B)	Fiber optic sensor
(C)	Door/Area sensor
(D)	Proximity sensor
(E)	Pressure sensor
(F)	Rotary encoder
(G)	Connector/Socket
(H)	Temp. controller
(I)	SSR/ Power controller
(J)	Counter
(K)	Timer
(L)	Panel meter
(M)	Tacho/ Speed/ Pulse meter
(N)	Display unit
(O)	Sensor controller
(P)	Switching mode power supply
(Q)	Stepper motor& Driver&Controller
(R)	Graphic/ Logic panel
(S)	Field network device
(T)	Software
(U)	Other

MT4Y/MT4W Series

Specifications

Series	MT4Y-DV-4□ MT4Y-DA-4□	MT4Y-AV-4□ MT4Y-AA-4□	MT4W-DV-4□ MT4W-DA-4□	MT4W-AV-4□ MT4W-AA-4□	MT4W-DV-1□ MT4W-DA-1□	MT4W-AV-1□ MT4W-AA-1□
Measurement input	DC voltage, ampere	AC voltage, ampere, Frequency	DC voltage, ampere	AC voltage, ampere, Frequency	DC voltage, ampere	AC voltage, ampere, Frequency
Power supply	100-240VAC 50/60Hz (Allowable voltage range: 90 to 110%)				12-24VDC (Allowable voltage range: 90 to 110%)	
Power consumption	5VA				5W	
Display method	7Segment LED display(red)(Character height: 14.2mm)					
Display accuracy	<ul style="list-style-type: none"> • 23°C±5°C - DC Type: F.S. ±0.1% rdg±2digit / AC Type: F.S. ±0.3% rdg±3digit DC/AC Type F.S. +0.3% rdg +3digit max. only for 5A terminal. • -10°C to 50°C - DC/AC Type: F.S.±0.5% rdg±3digit 					
Max. allowable input	110% F.S for each measured input range					
A/D conversion method	Practical oversampling using successive approximation ADC					
Sampling cycle	DC type: 50ms, AC type: 16.6ms					
Max. indication range	-1999 to 9999(4digit)					
Preset output	<ul style="list-style-type: none"> • Relay output - Contact capacity: 250VAC 3A, 30VDC 3A / Contact composition: N.O(1a) • NPN/PNP Open collector output - 12-24VDC ±2V 50mA Max. (Resistive load) 					
Sub output (Transmission output)	<ul style="list-style-type: none"> • RS485 communication output - Baud rate: 1200/2400/4800/9600, Communication method: 2-wire half duplex, Synchronous method: Asynchronous method, Protocol: Modbus type • Serial/BCD output - NPN Open collector output: 12-24VDC Max. 50mA(Resistive load) • DC4-20mA output - Resolution: 12,000 division(Load resistance max. 600Ω) 					
AC measuring function※1	Selectable RMS or AVG					
Frequency measurement function※1	Measurement range : 0.100 to 9999Hz(Variable by decimal point position)					
Hold function※2	Includes(External hold function)					
Insulation resistance	Min. 100MΩ(at 500VDC megger) between external terminal and case					
Dielectric strength	2,000VAC for 1minute between external terminal and case					
Noise strength	±2kV the square wave noise(pulse width : 1μs) by the noise simulator					
Vibration	Mechanical	0.75mm amplitude at frequency of 10 to 55Hz(for 1 min.) in each of X, Y, Z directions for 2hours				
	Malfunction	0.5mm amplitude at frequency of 10 to 55Hz(for 1 min.) in each of X, Y, Z directions for 10minutes				
Shock	Mechanical	100m/s²(approx. 10G) in each of X, Y, Z directions for 3 times				
	Malfunction	300m/s²(approx. 30G) in each of X, Y, Z directions for 3 times				
Relay life cycle	Malfunction	Min. 20,000,000 operations				
	Mechanical	Min. 100,000 operations(250VAC 3A Load current)				
Environ-ment	Ambient temperature	-10 to 50°C, storage: -20 to 60°C				
	Ambient humidity	35 to 85%RH, storage: 35 to 85%RH				
Insulation type	Double insulation or reinforced insulation (Mark: □, dielectric strength between the measuring input part and the power part: 1kV)					
Approval	CE c RU us				CE	
Unit weight	Approx. 134g			Approx. 211g		

※1: AC measuring function, and frequency measuring function are only for AC measuring input type.

If only frequency input the AC type(display method of measuring input) which option is in MT4W, MT4W will operate the only indicating type.

※2: MT4Y-□-4N model has no hold function.

※Environment resistance is rated at no freezing or condensation.

Front panel identification

MT4Y Series

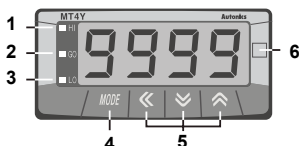

1. HI : High output indication of preset
2. GO : GO output indication of preset
3. LO : Low output indication of preset

MT4W Series

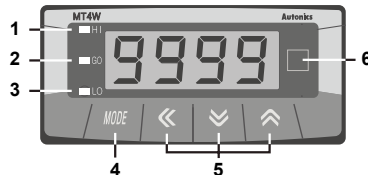

4. MODE key : Mode Key
5. : Moves digit, enters parameter mode, : changes SV
6. Unit label part

※There is no 1, 2, 3 on a display panel of MT4Y-□-4N, 45, 46 and MT4W-□-4N.

※In MT4Y-□-□3, □4, OUT is used for Go output display and there is no 1, 3 in display panel.

■ Connections

◎ Measuring input connection of MT4Y Series

● MT4Y-DV-4□

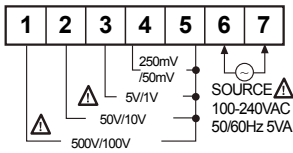

● MT4Y-AV-4□

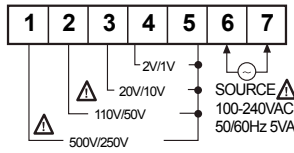

● MT4Y-DA-4□

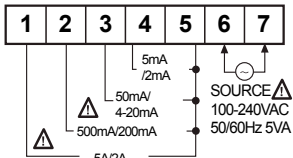

● MT4Y-AA-4□

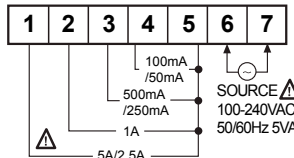

◎ Output terminal of connection of MT4Y Series

● MT4Y-□-4N (Indicator)

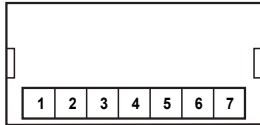

● MT4Y-□-40

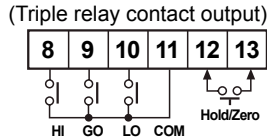

● MT4Y-□-41

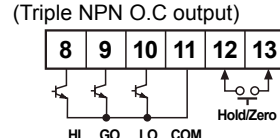

● MT4Y-□-42

(Triple PNP O.C output)

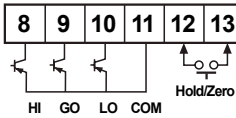

● MT4Y-□-43

(Relay output+Transmission output)

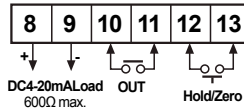

● MT4Y-□-44

(Relay+RS485 communication output)

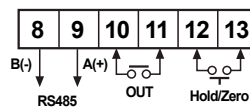

● MT4Y-□-45

(BCD Dynamic output)

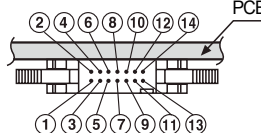
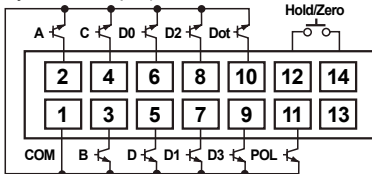

※ Hirose connector pin header model of the unit : HIF3BA-14PA-2.54DS

※ Contact Hirose Electric to purchase socket and wires of Hirose connector.

[Socket : HIF3BA-14D-2.54R]

● MT4Y-□-46 (Low speed serial output)

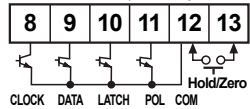

※ POL : When a display value is "-", the signal of "-" will be outputted.

◎ Measuring input connection of MT4W Series

● MT4W-DV-□□

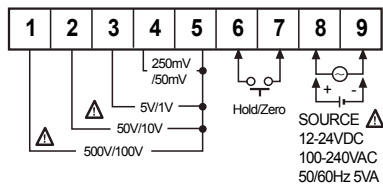

● MT4W-AV-□□

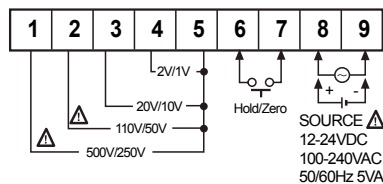

● MT4W-DA-□□

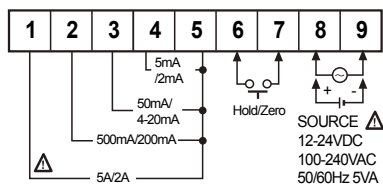

● MT4W-AA-□□

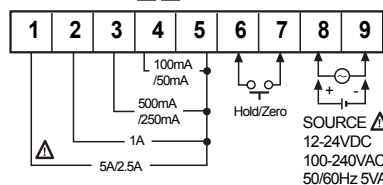

(A)	Photo electric sensor
(B)	Fiber optic sensor
(C)	Door/Area sensor
(D)	Proximity sensor
(E)	Pressure sensor
(F)	Rotary encoder
(G)	Connector/Socket
(H)	Temp. controller
(I)	SSR/ Power controller
(J)	Counter
(K)	Timer
(L)	Panel meter
(M)	Tacho/ Speed/ Pulse meter
(N)	Display unit
(O)	Sensor controller
(P)	Switching mode power supply
(Q)	Stepper motor& Driver&Controller
(R)	Graphic/ Logic panel
(S)	Field network device
(T)	Software
(U)	Other

MT4Y/MT4W Series

◎ Output terminal connection of MT4W Series

- **MT4W-□-□0** (Triple relay contact output + Transmission output)

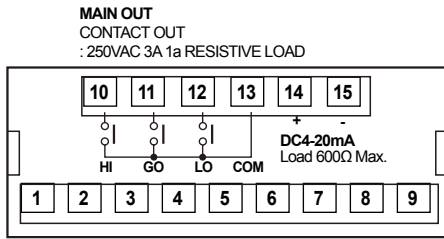

- **MT4W-□-□1** (Triple relay contact output)

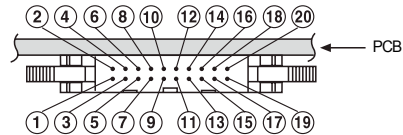
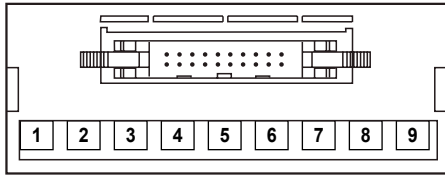
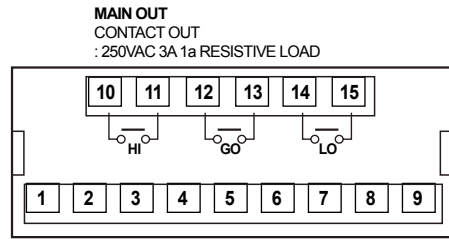

※ Hirose connector pin header model of the unit : HIF3BA-20PA-2.54DS
 ※ Contact Hirose Electric to purchase socket and wires of Hirose connector. [Socket: HIF3BA-20D-2.54R]

- **MT4W-□-□2 / MT4W-□-□3** (Triple NPN/PNP open collector output+BCD output)

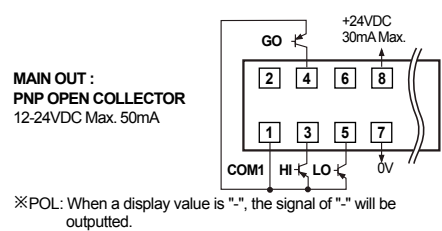
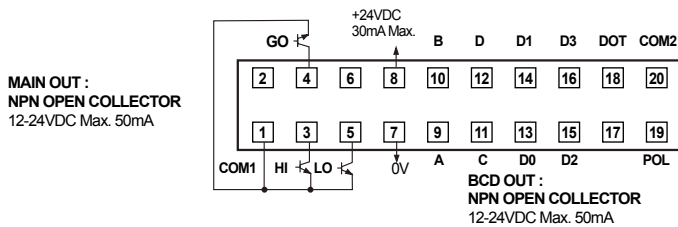

- **MT4W-□-□4 / MT4W-□-□5** (Triple NPN/PNP open collector output+Transmission output)

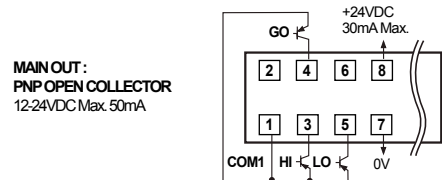
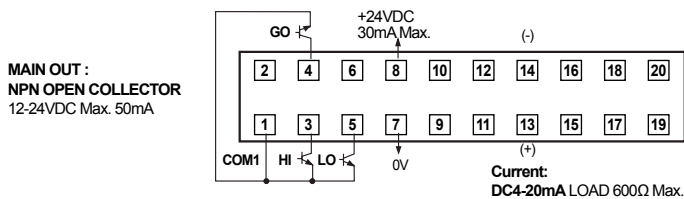

- **MT4W-□-□6 / MT4W-□-□7** (Triple NPN/PNP open collector output+Low speed serial output)

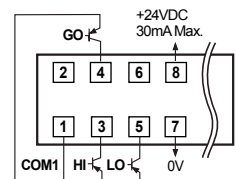
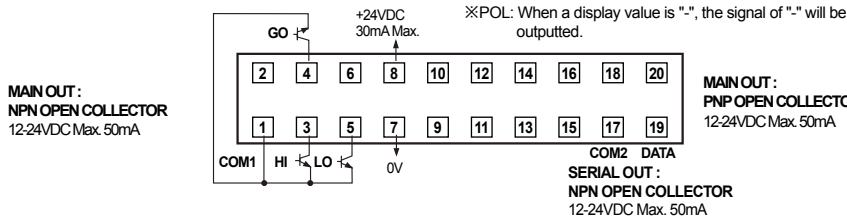

- **MT4W-□-□8 / MT4W-□-□9** (Triple NPN/PNP open collector output+RS485 output)

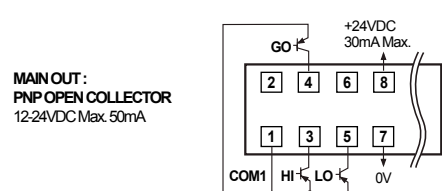
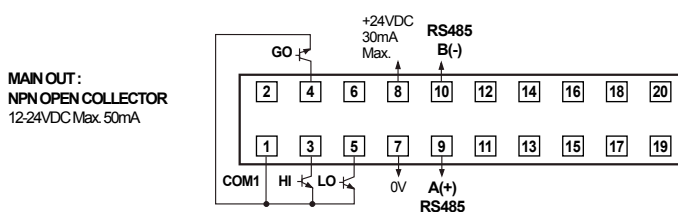

■ Dimensions

(unit: mm)

● MT4Y-□-4N, 45, 46

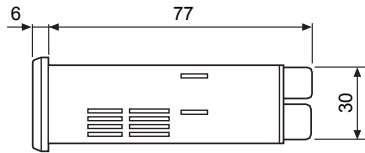
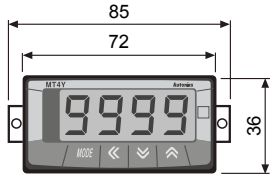

<MT4Y-□-4N, 40 to 44, 46>

● Panel cut-out

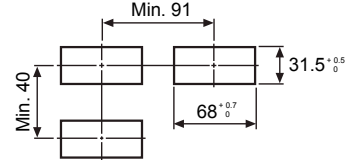

● MT4Y-□-43, 44

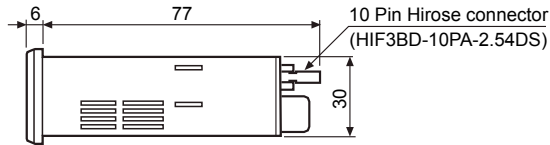

<MT4Y-□-45>

● MT4Y-□-40, 41, 42



● MT4W-□-□N (Indicator)

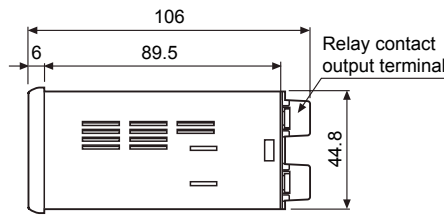
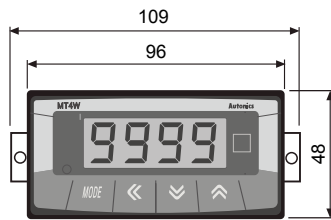

※ There is no Relay contact output terminal block in indication type.

< MT4W-□-□N, MT4W-□-□0, □1 >

● Panel cut-out

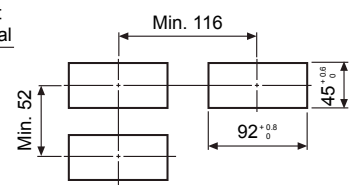

● MT4W-□-□0 to □9

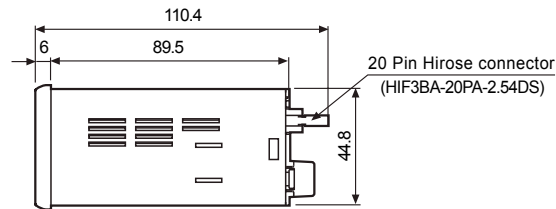

< MT4W-□-□2 to □9 >

■ Parameter setting

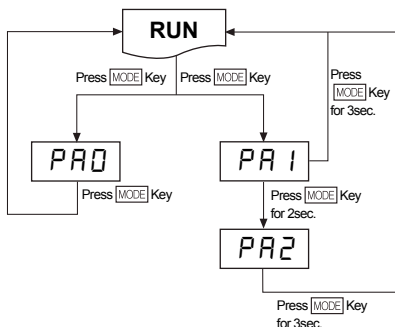

※ Press **[MODE]** key in **RUN** status, it will advance to **[PA0]**(Parameter 0) group.

※ Press **[MODE]** key for 2 sec. in **RUN** mode, **[PA1]** is displayed.

※ Press **[MODE]** key for 4 sec. in **RUN** mode, **[PA2]** is displayed after **[PA1]**.

When pressing **[MODE]** key continually, it stops displaying at **[PA2]**.

※ It is advanced to current display parameter releasing **[MODE]** key at **[PA1]** or **[PA2]**.

※ Press **[MODE]** key for 3 sec., it is returned to **RUN** at any position.

※ If any key is not touched for 60 sec. in each parameter, it returns to **RUN** mode.

※ After return to **RUN** mode, press **[MODE]** key within 2 sec., it returns to previous parameter. (Refer to the below descriptions for set parameter.)

※ It cannot advance to **[PA0]** when preset output operation mode of **[PA2]** is **[OFF]**.

(A)	Photo electric sensor
(B)	Fiber optic sensor
(C)	Door/Area sensor
(D)	Proximity sensor
(E)	Pressure sensor
(F)	Rotary encoder
(G)	Connector/Socket
(H)	Temp. controller
(I)	SSR/Power controller
(J)	Counter
(K)	Timer
(L)	Panel meter
(M)	Tacho/Speed/Pulse meter
(N)	Display unit
(O)	Sensor controller
(P)	Switching mode power supply
(Q)	Stepper motor& Driver&Controller
(R)	Graphic/Logic panel
(S)	Field network device
(T)	Software
(U)	Other

MT4Y/MT4W Series

Parameter 1 group

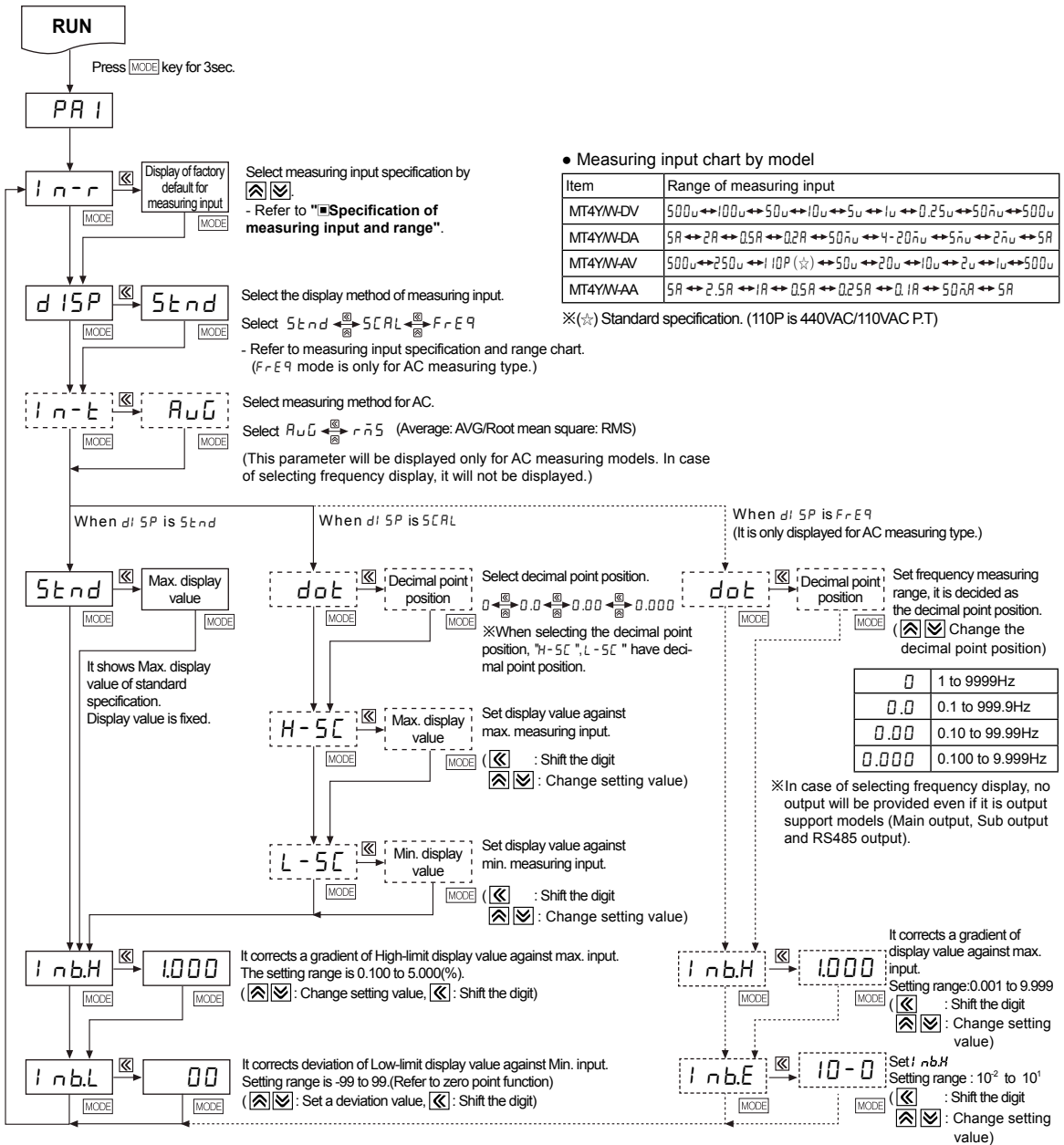

※After setting each mode, press **MODE** key for 2 sec. to return to RUN.

※If any key is untouched for 60sec. after advance to Parameter, it will return to RUN.

Factory defaults

Parameter	MT4Y/W-DV	MT4Y/W-DA	MT4Y/W-AV	MT4Y/W-AA	Parameter	MT4Y/W-DV	MT4Y/W-DA	MT4Y/W-AV	MT4Y/W-AA
<i>In-r</i>	500 μ	5A	500 μ	5A	<i>Inb.H</i>	1.000	1.000	1.000	1.000
<i>dISP</i>	<i>Stnd</i>	<i>Stnd</i>	<i>Stnd</i>	<i>Stnd</i>	<i>Inb.L</i>	00	00	00	00
<i>In-t</i>	—	—	<i>AUG</i>	<i>AUG</i>	<i>dot</i>	0.0	0.000	0.0	0.000
<i>Stnd</i>	500.0	5.000	500.0	5.000	<i>Inb.E</i>	—	—	10-0	10-0

Parameter 2 group

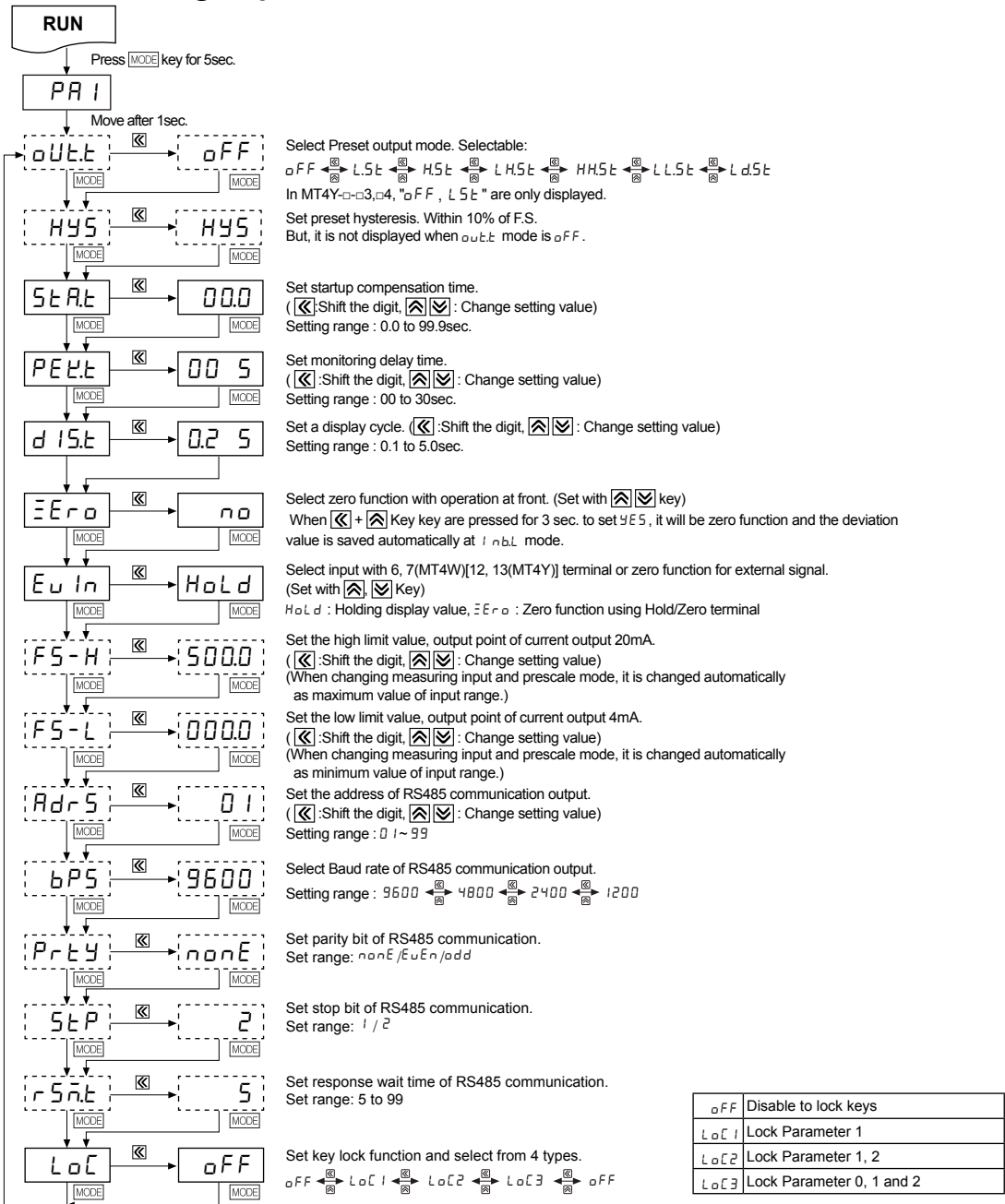

※The dotted mode is only displayed for output type.

※After setting each mode, press [MODE] key for 2 sec. to return to RUN mode.

※If any key is untouched for 60sec. after advance to PARAMETER, it will return to RUN mode.

Factory defaults

Parameter	MT4Y/W-DV	MT4Y/W-DA	MT4Y/W-AV	MT4Y/W-AA	Parameter	MT4Y/W-DV	MT4Y/W-DA	MT4Y/W-AV	MT4Y/W-AA
oUt	oFF	oFF	oFF	oFF	EuIn	HoLd	HoLd	HoLd	HoLd
HYS	001	001	001	001	FS-H	5000	5000	5000	5000
StAr	00.0	00.0	00.0	00.0	FS-L	0000	0000	0000	0000
PElt	00.5	00.5	00.5	00.5	AdRS	01	01	01	01
dISt	0.2.5	0.2.5	0.2.5	0.2.5	bPS	9600	9600	9600	9600
Err	no	no	no	no	LoC	oFF	oFF	oFF	oFF

(A)	Photo electric sensor
(B)	Fiber optic sensor
(C)	Door/Area sensor
(D)	Proximity sensor
(E)	Pressure sensor
(F)	Rotary encoder
(G)	Connector/Socket
(H)	Temp. controller
(I)	SSR/Power controller
(J)	Counter
(K)	Timer
(L)	Panel meter
(M)	Tacho/Speed/Pulse meter
(N)	Display unit
(O)	Sensor controller
(P)	Switching mode power supply
(Q)	Stepper motor& Driver&Controller
(R)	Graphic/Logic panel
(S)	Field network device
(T)	Software
(U)	Other

MT4Y/MT4W Series

Parameter 0 group

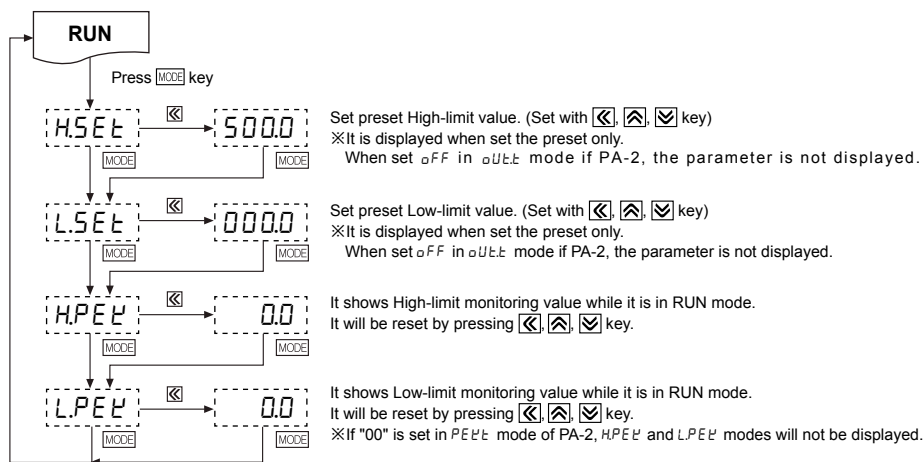

※If any key is untouched for 60sec. after advance to Parameter, it will return to **RUN** mode.

Factory defaults

Parameter	MT4Y/W-DV	MT4Y/W-DA	MT4Y/W-AV	MT4Y/W-AA	Parameter	MT4Y/W-DV	MT4Y/W-DA	MT4Y/W-AV	MT4Y/W-AA
HSEt	500.0	5.000	500.0	5.000	HPEt	0.0	0.000	0.0	0.000
LSEt	0.000	0.000	0.000	0.000	LPEt	0.0	0.000	0.0	0.000

Measuring input and range

Type	Measuring input and range	Input impedance	Display range [5tnd]	Prescale display range [5CR L]										
DC Volt	0-500V [500u]	4.33MΩ	0.0 to 500.0	<table border="1"> <thead> <tr> <th>dot</th> <th>Display range</th> </tr> </thead> <tbody> <tr> <td>0</td> <td>-1999 to 9999</td> </tr> <tr> <td>0.0</td> <td>-199.9 to 999.9</td> </tr> <tr> <td>0.00</td> <td>-19.99 to 99.99</td> </tr> <tr> <td>0.000</td> <td>-1.999 to 9.999</td> </tr> </tbody> </table> <p>(The display range is changed according to the decimal point position.)</p> <p>※Please connect proper terminal its max. input voltage is within 30 to 100% of input terminal. When it is higher than input voltage, it may cause a breakdown of terminal and over display range and the accuracy is decreased when it is connected to the terminal under 30%.</p> <p>※110P is standard specification 440V/110VAC P.T.</p>	dot	Display range	0	-1999 to 9999	0.0	-199.9 to 999.9	0.00	-19.99 to 99.99	0.000	-1.999 to 9.999
	dot	Display range												
	0	-1999 to 9999												
	0.0	-199.9 to 999.9												
	0.00	-19.99 to 99.99												
	0.000	-1.999 to 9.999												
	0-100V [100u]	4.33MΩ	0.0 to 100.0											
	0-50V [50u]	433.15kΩ	0.00 to 50.00											
0-10V [10u]	433.15kΩ	0.00 to 10.00												
0-5V [5u]	43.15kΩ	0.000 to 5.000												
0-1V [1u]	43.15kΩ	0.000 to 1.000												
0-250mV [0.25u]	2.15kΩ	0.0 to 250.0												
0-50mV [50nu]	2.15kΩ	0.00 to 50.00												
DC Ampere	0-5A [5A]	0.01Ω	0.000 to 5.000											
	0-2A [2A]	0.01Ω	0.000 to 2.000											
	0-500mA [0.5A]	0.1Ω	0.0 to 500.0											
	0-200mA [0.2A]	0.1Ω	0.0 to 200.0											
	0-50mA [50na]	1.0Ω	0.00 to 50.00											
	4-20mA [4-20]	1.0Ω	4.00 to 20.00											
	0-5mA [5na]	10.0Ω	0.000 to 5.000											
	0-2mA [2na]	10.0Ω	0.000 to 2.000											
AC Volt	0-500V [500u]	4.98MΩ	0.0 to 500.0											
	0-250V [250u]	4.98MΩ	0.0 to 250.0											
	0-110V [110P]	1.08MΩ	0.0 to 440.0											
	0-50V [50u]	1.08MΩ	0.00 to 50.00											
	0-20V [20u]	200kΩ	0.00 to 20.00											
	0-10V [10u]	200kΩ	0.00 to 10.00											
	0-2V [2u]	20kΩ	0.000 to 2.000											
0-1V [1u]	20kΩ	0.000 to 1.000												
AC Ampere	0-5A [5A]	0.01Ω	0.000 to 5.000											
	0-2.5A [2.5A]	0.01Ω	0.000 to 2.500											
	0-1A [1A]	0.05Ω	0.000 to 1.000											
	0-500mA [0.5A]	0.1Ω	0.0 to 500.0											
	0-250mA [0.25A]	0.1Ω	0.0 to 250.0											
	0-100mA [0.1A]	0.5Ω	0.0 to 100.0											
0-50mA [50na]	0.5Ω	0.00 to 50.00												

■ Functions

◎ AC frequency measurement function

[PA 1 group: $d15P$]

It measures input signal frequency when it is AC input. It uses fixed decimal point[PA1: $d0E$], measured range can be changed by setting and measured range of decimal point position is as below chart. It is available to adjust the upper gradient at [PA 1: $i nbH$]and [PA 1: $i nbE$]. In order to measure frequency normally, input signal, over 10% F.S. of the measured range, should be supplied. Please select the proper point of

① Measuring range

Decimal point position	0.000	0.00	0.0	0
Measurement range	0.100 to 9.999Hz	0.10 to 99.99Hz	0.1 to 999.9Hz	1 to 9999Hz

※Accuracy of frequency measurement :

Below 1kHz, F.S. $\pm 0.1rdg \pm 2digit$.

From 1kHz to 10kHz, F.S. $\pm 0.3rdg \pm 2digit$.

② $i nbH$: 0.100 to 9.999 [Gradient adjustment of high value]

③ $i nbE$: $10^{-2}, 10^{-1}, 10^0, 10^1$ [Index adjustment of $i nbH$]

◎ Zero adjustment function

(Deviation correction function of low limit display value)

It adjusts the display value of the optional configured input value as zero by force, zero point error can be adjusted with 3 ways as below. When zero point adjustment with front key and Hold terminal is finished normally, zero point of measurement terminal is displayed and the adjusted value at saved in $i nbL$ automatically.

Operation	Input correction value	Front panel key	External input signal
Description	PA 1: Direct input correction value method at $i nbL$ mode.	Press both $\left[\text{Key 1} \right]$ and $\left[\text{Key 2} \right]$ keys for 3 sec. at the measuring mode.	Short-circuit external Hold terminal no.11,12 [no. 6, 7(MT4W)]over min. 50m. ※It is enable to use in option mode.

※Refer to "◎ Error correction function", "◎ Error display function" and "■ Parameter 2" for function and error.

◎ Current output(DC4-20mA) scale function [PA2 group: $F5-H / F5-L$]

It sets current output for the display value at the output current DC 4-20mA.

It sets display value for 4mA at $F5-L$ and 20mA at $F5-H$ and the range between $F5-H$ and $F5-L$ should be 10%

※When min. set interval between $F5-H$ and $F5-L$ is set as under 10% F.S., it changed as over 10% F.S. automatically.)

※Preset display value is fixed to output as 4mA at under $F5-L$ and 20mA at over $F5-H$.

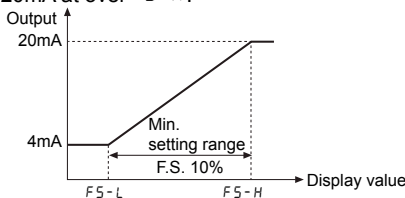

◎ Initialization function

It initializes as the factory default status. If press $\left[\text{Key 1} \right]$, $\left[\text{Key 2} \right]$, $\left[\text{Key 3} \right]$ keys together for 2sec. in RUN mode, $i nbL$ mode and the setting value ($n0$) is displayed every 0.5 sec. and it will be initialized as the factory default when press $\left[\text{MODE} \right]$ key after

change $n0 \rightarrow 4E5$.

◎ Startup compensation time function

[PA 2 group : $5tRt$]

This time function limits the operation of an output until the measured input(overvoltage or inrush current) is stable at moment of power on. All outputs are off during startup compensation time setting after power is applied.

Setting range : 00.0 to 99.9(unit: sec.)

Factory default : 00.0

◎ Error display function

Display	Description
HHHH	Flashing when measuring input is exceeded the max. allowable input(110%)
LLLL	Flashing when measuring input is exceeded the minx. allowable input(-10%)
d-HH	Lights when display input is exceeded the max. display range(9999) or $H-5E$ setting value
d-LL	Lights when display input is exceeded the min. display range (-1999) or $L-5E$ setting value
F-HH	Flashes when measuring frequency is exceeded themax. measuring value (9999)
00Er	Flashes when it exceeds zero adjustment range(± 99)

※Error display is released automatically when it is in the measured and display range.

※"LLLL" is displayed when the measuring input is 4-20mA.

※ After flashing "00Er" 2 times when it exceeds the zero range, it returns to RUN mode.

◎ Display scale function[PA 1 group: $H-5E / L-5E$]

This function is to display setting(-1999 to 9999) of particular High/Low-limit value in order to display High/Low-limit value of measured input. If measured inputs are 'a' and 'b' and particular values are 'A' and 'B', it will display $a=A$, $b=B$ as below graphs.

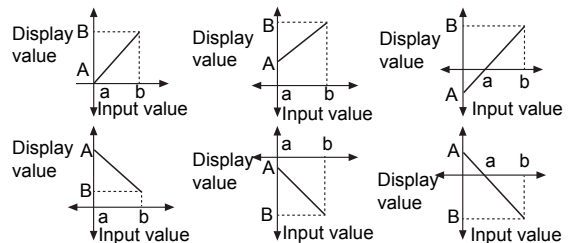

◎ Gradient correction function

[PA 1 group: $i nbH$]

This function is to correct a gradient of prescale value and display value. (Fig.1) Display value Y can be used as α , β times against X input value by correction function[$i nbH$]. And also can be used as correction function of max. display value($H-5E$). Adjustment range is 0.100 to 5.000 and multiply current gradient.

Ex)Input : DC200mV, Display : 3.000 for MT4W-DV

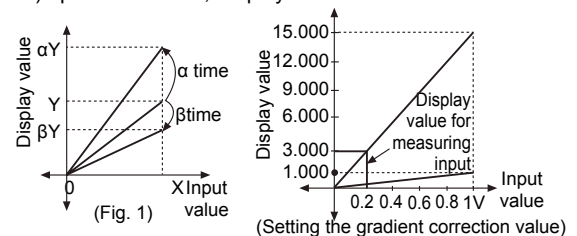

(A)	Photo electric sensor
(B)	Fiber optic sensor
(C)	Door/Area sensor
(D)	Proximity sensor
(E)	Pressure sensor
(F)	Rotary encoder
(G)	Connector/Socket
(H)	Temp. controller
(I)	SSR/ Power controller
(J)	Counter
(K)	Timer
(L)	Panel meter
(M)	Tacho/ Speed/ Pulse meter
(N)	Display unit
(O)	Sensor controller
(P)	Switching mode power supply
(Q)	Stepper motor& Driver&Controller
(R)	Graphic/ Logic panel
(S)	Field network device
(T)	Software
(U)	Other

MT4Y/MT4W Series

- ① Select 0-1VDC for measuring input in Parameter1.
- ② Standard specification in input : 0-1VDC and 1.000 therefore it has to be 15.000 ($H-5\%$) for 1VDC(input) in order to display 3.000 for DC200mV(input). But it is disable due to setting range is 9.999
- ③ In this case, please check below chart.
Please set as $i_{nb.H} \times H-5\% = 15.000$

Setting	$H-5\%$	$L-5\%$	$i_{nb.H}$	Other
①	Disable	0.000	1.000	—
②	7.500	0.000	2.000	It will be the same display value.
③	5.000	0.000	3.000	
④	3.750	0.000	4.000	
⑤	3.000	0.000	5.000	

◎ Error correction function [PA 1 group : $i_{nb.H}$ / $i_{nb.L}$]

It corrects display value error of measured input.

$i_{nb.L}$: ± 99 (Adjust deviation of low value)

$i_{nb.H}$: 5.000 to 0.100 [Correct gradient(%) of high value]

Display value=(Measured value $\times i_{nb.H}$) + $i_{nb.L}$

Ex)Low value correction

When there is an application where there is a residual voltage of 1.2V, but a 0V display is desired, then it is possible by adjusting the $i_{nb.L}$ parameter setting to 12(offset correcting value or equal to 1.2V without decimal) that the desired display value of 0 can be achieved.

Ex)High value correction

When there is an application where the high actual value of display is 501 and exceeds the 500V display range, then it is possible by adjusting the $i_{nb.H}$ parameter setting to 0.998(calculated by desired value of 500/actual value of 501), that the desired value can be achieved.

※The offset correction range of $i_{nb.L}$ is within -99 to 99 for D-0, D-1 digit regardless of decimal point.

◎ Display cycle delay function [PA 2 group : d_{15t}]







In some applications the measured input may fluctuate which in turn causes the display to fluctuate. By adjusting the display cycle delay function time in the d_{15t} mode in parameter 2, the operator can adjust the display time within a range of 0.1 sec to 5 sec. For example, if the operator sets the display cycle time to 4.0 sec., the display value displayed will be the average input value over 4 sec. and also will show any changes if any every 4 sec.

◎ Monitoring peak display value function [PA 0 group: H_{PEL} / L_{PEL} , PA 2 group: PEL]

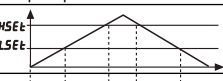
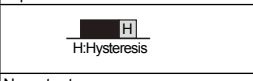
It monitors max./min. value of display value based on the current displays value and then displays the data at H_{PEL} , L_{PEL} of parameter 0. Set the delay time(0 to 30 sec.) at PEL of parameter 2 in order to prevent malfunction caused by initial overcurrent or overvoltage, when monitoring the peak value. Delay time is 0 to 30 sec. and it starts to monitor the peak value after the set time. When pressing any one of \leftarrow \rightarrow \uparrow \downarrow keys at H_{PEL} , L_{PEL} of parameter 0, the monitored data is initialized.

※Monitoring function is not indicate when the delay time is set as "00 5" at PEL of parameter 2.

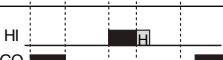
◎ Preset output Mode [PA 2 group : o_{ult} mode]

Mode	Output operation	Operation
o_{FF}		
$L.5t$		If it is equal or smaller than low setting value, LO output will be ON. If it is bigger than low setting value, GO output will be ON.
$H.5t$		If it is equal or bigger than high setting value, HI output will be ON. If it is equal or smaller than high setting value, GO output will be ON.
$L.H.5t$		If it is equal or smaller than low setting value and equal or bigger than high setting value, the output will be ON. If it is bigger than Low setting value and smaller than high setting value, GO output will be ON.
$H.H.5t$		If it is equal or bigger than low set and equal or bigger than high set value, output will be ON. If it is smaller than low setting value and high setting value, GO output will be ON.
$L.L.5t$		If it is equal or smaller than low setting value, LO output will be ON. If it is equal or smaller than high setting value, HI output will be ON. If it is bigger than low setting value and High setting value, GO output will be ON.
$L.d.5t$		This operation is the same as $L.5t$. But it doesn't operate at initial low set value, it will operate at next low set value. If this is higher than low set value, Go output will be ON.

※"H" means hysteresis and able to set 1 to 99 at "H45" mode in para-meter 2 among above comparison output chart.

※In MT4Y-□-□3, □4, $L.5t$ modes are only available to use.

◎ Sub output(Transmission function)

- RS485 communication output

It is able to set address(01 to 99)

It is able to transmit by selecting modulation speed (Transmitted number of signal per 1sec.) of serial transmission. (Selectable 1200, 2400, 4800, 9600bps)

- Low-speed serial output

It outputs current display value as Low-frequency(50Hz) type.

- Current output(DC4-20mA)

It outputs DC4-20mA against High/Low-limit scale. (Resolution: 12000 division)

- BCD output

It outputs display value as BCD Code..

※Only one sub-output is selectable.

(More than one sub-output is not allowed.)

© Time chart of BCD output and Serial output

- BCD output(Negative logic)

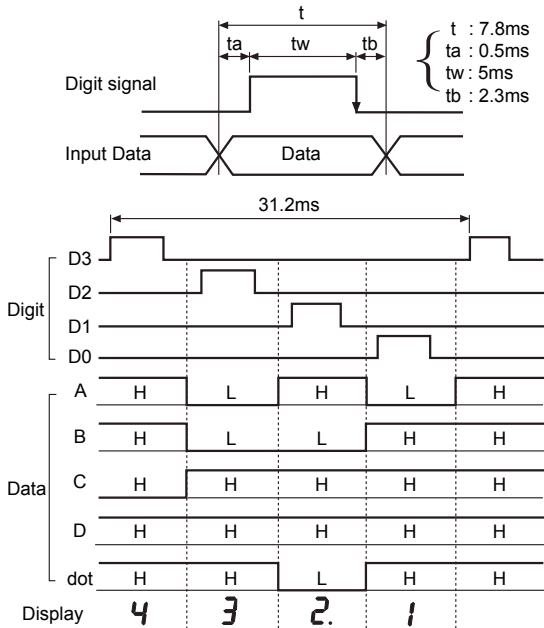

- Serial output(Negative logic)-Clock frequency:50Hz

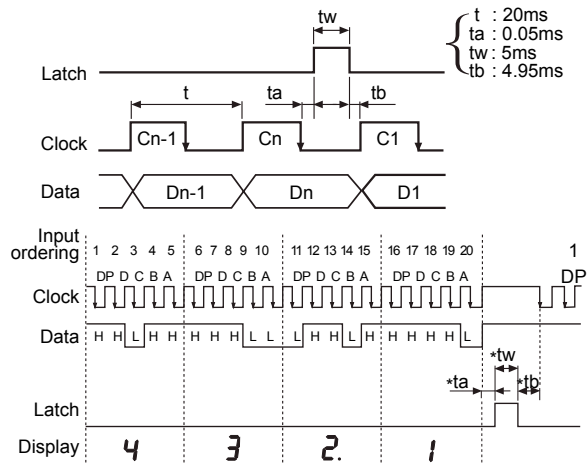

(A)	Photo electric sensor
(B)	Fiber optic sensor
(C)	Door/Area sensor
(D)	Proximity sensor
(E)	Pressure sensor
(F)	Rotary encoder
(G)	Connector/Socket
(H)	Temp. controller
(I)	SSR/ Power controller
(J)	Counter
(K)	Timer
(L)	Panel meter
(M)	Tacho/ Speed/ Pulse meter
(N)	Display unit
(O)	Sensor controller
(P)	Switching mode power supply
(Q)	Stepper motor& Driver&Controller
(R)	Graphic/ Logic panel
(S)	Field network device
(T)	Software
(U)	Other

MT4N/MT4Y/MT4W Common Features

■ Communication output

The protocol is changed as Modbus type.

◎ Interface

Standard	EIA RS485
Number of connections	Max. 31 units.(It is available to set address 01 to 99.)
Communication method	2 wire half duplex
Synchronous method	Asynchronous type
Communication distance	Within max. 800m
Communication speed	1200, 2400, 4800, 9600bps
Start bit	1bit(Fixed)
Stop bit	1bit(Fixed)
Parity bit	none
Data bit	8bit(Fixed)
Protocol	Modbus RTU

◎ Application of system organization

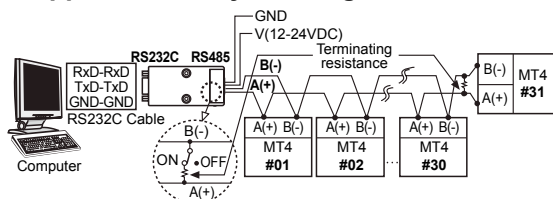

- ※ It is recommended to use communication converter, RS232C to RS485(SCM-38I,sold separately), USB to RS485 converter(SCM-US48I, sold separately).
- ※ Please use a proper twist pair for RS485 communication.

◎ Communication control ordering

1. The communication ordering of MT4 Series is Modbus RTU. (PI-MBUS-300-REV.J)
2. After 0.5sec. being supplied the power into the master system, it starts to communicate.
3. Initial communication will be started by the master system. When a command comes out from the master system, MT4 Series will respond.

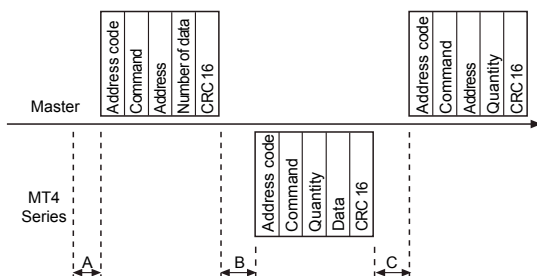

※A → Min. 0.5sec. after supplying power

- B →
- 9600bps : Within 10.4ms
 - 4800bps : Within 20.8ms
 - 2400bps : Within 41.6ms
 - 1200bps : Within 83.3ms

- C →
- 9600bps : Within 4.2ms
 - 4800bps : Within 8.4ms
 - 2400bps : Within 16.7ms
 - 1200bps : Within 33.4ms

◎ Communication command and block

The format of query and response

• Query

Address code	Command	Start address	Number of data	CRC16
①	②	③	④	⑤
Calculation range of CRC16				

- ①Address code : This code is the master system can discern MT4 Series and able to set within range 01H-63H.
- ②Command : Read command for input register.
- ③Start address : The start address of input register to read (Start address), it is available to select 0000 to 0003 for start address.
- ④Number of data : The number of 16 bit data from start address(No. of points)
- ⑤CRC16 : It is a Check Sum checking the whole frame and it is for more reliable transmit/receive to check the error between transmitter and receiver.

• Response

Address code	Response Command	Number of data	PV	Decimal point position	Hi peak value	Low peak value	CRC16
①	②	③	④	⑤	⑥	⑦	⑧
Calculation range of CRC16							

- ①Address code : Distinguish MT4 Series and the number is available from 01H-63H.
- ②Response command : Response for a read command of input register. (Refer to Modbus mapping table)
- ③Amount of data : The number of 8 bit data on star code. (No. of points)
- ④PV : It is 16 Bit data, measuring and display value of MT4 Series. The decimal point data is not included in the transmitting PV.
- ⑤Decimal point position : It is the decimal point position is set in *dot* mode of Parameter 1.
- ⑥Hi peak value : The max. display value of PV
- ⑦Lo peak value : The min. display value of PV
- ⑧CRC16 : It is a Check Sum checking the whole block.

◎ Application of communication command

In case, the display value of multi panel meter is 220.3V, the decimal point is 0.0, Hi Peak value is 220.4 and Lo Peak value is 0000.

• Query

Address code	Command	Start address		Number of data		CRC16	
		High	Low	High	Low	Low	High
01	04	00	00	00	04	F1	C9

• Response

Address code	Response command	Amount of data	Measured value		dot position		Hi Peak		Lo Peak		CRC16		NULL
			High	Low	High	Low	High	Low	High	Low	Low	High	
01	04	08	08	9B	00	01	08	9C	00	00	CRC16	00	

※ It is responded with 1 byte sized NULL(00H) at the end of response frame (next BCC 16).

MT4N/MT4Y/MT4W Common Features

● Error processing(Slave → Master)

1. Non-supportable command

Address code	Response command	Exception code	CRC16	
01	81	01	81	90

※Set a received highest bit and send it to response command and exception code 01.

2. A start code of queried data is inconsistent with the transmittable code

Address code	Response command	Exception code	CRC16	
01	81	02	81	90

※Set a received highest bit and send it to response command and exception code 02.

3. The number of queried data is bigger than transmittable one

Address code	Response command	Exception code	CRC16	
01	81	03	—	—

※Set a received highest bit and send it to response command and exception code 03.

◎ Modbus Mapping Table

● Read Input Register

Start address	Com-mand	Transmission	Remark
30001 (0000)	04	Process value • Standard: Transmit up to -5 to 110% of display range • Scale: Able to transmit from -1999 to 9999% of display range	Data transmittance for measuring error • Standard : Transmit "9999" if "HHHH" is displayed. Transmit "-1999" if "LLLL" is displayed. • Scale : Transmit the setting value of H-SC and L-SC. Transmit "9999" if "d-HH" is displayed. Transmit "-1999" if "d-LL" is displayed
30002 (0001)	04	Dot setting value	Transmit the position setting value of decimal point of PA-1 dot mode. • Standard: 0.00 0 → 0003H, 0.00 → 0002H, 0.0 → 0001H, 0 → 0000H, • Scale: 0.000 → 0103H, 0.00 → 0102H, 0.0 → 0101H, 0 → 0100H,
30003 (0002)	04	High Peak value	Transmit the max. display value of measuring display value
30004 (0003)	04	Low Peak value	Transmit the min. display value of measuring display value

● Read Coil Status

Start address	Com-mand	Transmission	Remark
00001 (0000)	01	Output status • 01h:Lo output • 02h:Go output • 04h:Hi output • 05h:Lo/Hi output	Transmit "1" if the output is ON and "0" for OFF.

◎ Setting of communication speed

It is available to set the communication speed at *bP5* mode of **PA 2**. The factory default is 9600bps.

◎ Setting of communication address (Setting range: 01 to 99)

It is able to set the communication speed at *Ad5* mode of **PA 2**. The factory default is **01**.

It is able to set the communication address up to 99 but only 31 units can be connected to higher system.

◎ CRC16 Table

● High order byte table

0	1	2	3	4	5	6	7	8	9	A	B	C	D	E	F	
0	0x00	0xC1	0x81	0x40	0x01	0xC0	0x80	0x41	0x01	0xC0	0x80	0x41	0x00	0xC1	0x81	0x40
1	0x01	0xC0	0x80	0x41	0x00	0xC1	0x81	0x40	0x00	0xC1	0x81	0x40	0x01	0xC0	0x80	0x41
2	0x01	0xC0	0x80	0x41	0x00	0xC1	0x81	0x40	0x00	0xC1	0x81	0x40	0x01	0xC0	0x80	0x41
3	0x00	0xC1	0x81	0x40	0x01	0xC0	0x80	0x41	0x01	0xC0	0x80	0x41	0x00	0xC1	0x81	0x40
4	0x01	0xC0	0x80	0x41	0x00	0xC1	0x81	0x40	0x00	0xC1	0x81	0x40	0x01	0xC0	0x80	0x41
5	0x00	0xC1	0x81	0x40	0x01	0xC0	0x80	0x41	0x01	0xC0	0x80	0x41	0x00	0xC1	0x81	0x40
6	0x00	0xC1	0x81	0x40	0x01	0xC0	0x80	0x41	0x01	0xC0	0x80	0x41	0x00	0xC1	0x81	0x40
7	0x01	0xC0	0x80	0x41	0x00	0xC1	0x81	0x40	0x00	0xC1	0x81	0x40	0x01	0xC0	0x80	0x41
8	0x01	0xC0	0x80	0x41	0x00	0xC1	0x81	0x40	0x00	0xC1	0x81	0x40	0x01	0xC0	0x80	0x41
9	0x00	0xC1	0x81	0x40	0x01	0xC0	0x80	0x41	0x01	0xC0	0x80	0x41	0x00	0xC1	0x81	0x40
A	0x00	0xC1	0x81	0x40	0x01	0xC0	0x80	0x41	0x01	0xC0	0x80	0x41	0x00	0xC1	0x81	0x40
B	0x01	0xC0	0x80	0x41	0x00	0xC1	0x81	0x40	0x00	0xC1	0x81	0x40	0x01	0xC0	0x80	0x41
C	0x00	0xC1	0x81	0x40	0x01	0xC0	0x80	0x41	0x01	0xC0	0x80	0x41	0x00	0xC1	0x81	0x40
D	0x01	0xC0	0x80	0x41	0x00	0xC1	0x81	0x40	0x00	0xC1	0x81	0x40	0x01	0xC0	0x80	0x41
E	0x01	0xC0	0x80	0x41	0x00	0xC1	0x81	0x40	0x00	0xC1	0x81	0x40	0x01	0xC0	0x80	0x41
F	0x00	0xC1	0x81	0x40	0x01	0xC0	0x80	0x41	0x01	0xC0	0x80	0x41	0x00	0xC1	0x81	0x40

● Low order byte table

0	1	2	3	4	5	6	7	8	9	A	B	C	D	E	F	
0	0x00	0xC0	0xC1	0x01	0xC3	0x03	0x02	0xC2	0xC6	0x06	0x07	0xC7	0x05	0xC5	0xC4	0x04
1	0xC0	0xC0	0xD0	0x0F	0xCF	0xCE	0x0E	0x0A	0xCA	0xCB	0xC7	0x05	0xC5	0xC4	0x04	
2	0x08	0x18	0x19	0xD9	0x1B	0xDB	0xDA	0x1A	0x1E	0xDE	0xDF	0x1F	0xDD	0x1D	0xDC	
3	0x14	0xD4	0xD5	0x15	0xD7	0x17	0x16	0xD6	0xD2	0x12	0x13	0xD3	0x11	0xD1	0xD0	0x10
4	0xF0	0x30	0x31	0xF1	0x33	0xF3	0x32	0x36	0xF6	0xF7	0x37	0xF5	0x35	0xF5	0x34	0xF4
5	0x3C	0xFC	0xFD	0x3D	0xFF	0x3F	0x3E	0xFE	0xFA	0x3A	0x3B	0xFB	0x39	0xF9	0xF8	0x38
6	0x28	0xE8	0xE9	0x29	0xEB	0x2B	0x2A	0xEA	0xEE	0x2E	0x2F	0xEF	0x2D	0xED	0xE0	0x2C
7	0xE4	0x24	0x25	0xE5	0x27	0xE7	0xE6	0x26	0x22	0xE2	0xE3	0x23	0xE1	0x21	0x20	0xE0
8	0xA0	0x60	0x61	0xA1	0x63	0xA3	0xA2	0x62	0x66	0xA6	0xA7	0x67	0xA5	0x65	0xA4	0xA4
9	0x6C	0xAC	0xAD	0x6D	0xAF	0x6F	0x6E	0xAE	0xAA	0x6A	0x6B	0xAB	0x69	0xA9	0xA8	0x68
A	0x78	0xB8	0xB9	0x79	0xBB	0x7B	0x7A	0xBA	0xBE	0x7E	0x7F	0xBF	0x7D	0xBD	0xBC	0x7C
B	0xB4	0x74	0x75	0xB5	0x77	0xB7	0xB6	0x76	0x72	0xB2	0xB3	0x73	0xB1	0x71	0x70	0xB0
C	0x50	0x90	0x91	0x51	0x93	0x53	0x52	0x92	0x96	0x56	0x57	0x97	0x55	0x95	0x94	0x54
D	0x9C	0x5C	0x5D	0x9D	0x5F	0x9F	0x9E	0x5E	0x5A	0x9A	0x9B	0x5B	0x99	0x59	0x58	0x98
E	0x88	0x48	0x49	0x89	0x4B	0x8B	0x8A	0x4A	0x4E	0x8E	0x8F	0x4F	0x8D	0x4D	0x4C	0x8C
F	0x44	0x84	0x85	0x45	0x87	0x47	0x46	0x86	0x82	0x42	0x43	0x83	0x41	0x81	0x80	0x40

■ Caution for using

- It is disable to modify Parameter(Baud rate, Address etc)related to communication of MT4 Series on line with upper systems such as PC, PLC etc. (Error will occur)
- First make communication Parameter of MT4 Series and master system one.
- It is not allow to set overlapping communication number at the same communication line. (Error will occur)
- Please use twist pair wire for RS485 communication.
- The total length of communication is 800m and max. 31 units can be connected.
- When connecting communication cable between MT4 Series and master systems, the vertical resistance(100 to 120Ω) must be installed at between both communication lines.
- The setting item of communication parameter is as below.
 - Start bit : 1bit(Fixed)
 - Stop bit : 1bit(Fixed)
 - Parity bit : None(Fixed)
 - Data bit : 8bit(Fixed)
 - Baud rate : 9600, 4800, 2400, 1200(Setting)
 - Address : 01 to 99(Setting)

(A)	Photo electric sensor
(B)	Fiber optic sensor
(C)	Door/Area sensor
(D)	Proximity sensor
(E)	Pressure sensor
(F)	Rotary encoder
(G)	Connector/Socket
(H)	Temp. controller
(I)	SSR/Power controller
(J)	Counter
(K)	Timer
(L)	Panel meter
(M)	Tacho/Speed/Pulse meter
(N)	Display unit
(O)	Sensor controller
(P)	Switching mode power supply
(Q)	Stepper motor& Driver&Controller
(R)	Graphic/Logic panel
(S)	Field network device
(T)	Software
(U)	Other